



KFC-241

Industrial

10/100BASE-T to 100BASE-FX

Media Converters

Installation Guide



DOC.110112

(C) 2011 KTI Networks Inc. All rights reserved. No part of this documentation may be reproduced in any form or by any means or used to make any derivative work (such as translation or transformation) without permission from KTI Networks Inc.

KTI Networks Inc. reserves the right to revise this documentation and to make changes in content from time to time without obligation on the part of KTI Networks Inc. to provide notification of such revision or change.

For more information, contact:

United States KTI Networks Inc.
P.O. BOX 631008
Houston, Texas 77263-1008

Phone: 713-2663891
Fax: 713-2663893
E-mail: kti@ktinet.com
URL: <http://www.ktinet.com/>

International Fax: 886-2-26983873
E-mail: kti@ktinet.com.tw
URL: <http://www.ktinet.com.tw/>

The information contained in this document is subject to change without prior notice.
Copyright (C) All Rights Reserved.

TRADEMARKS

Ethernet is a registered trademark of Xerox Corp.

FCC NOTICE

This device complies with Part 15 of the FCC Rules. Operation is subject to the following two conditions: (1) This device may not cause harmful interference, and (2) This device must accept any interference received, including the interference that may cause undesired operation.

CE NOTICE

Marking by the symbol indicates compliance of this equipment to the EMC directive of the European Community. Such marking is indicative that this equipment meets or exceeds the following technical standards:

EMC Class A

EN55022:2006/A1:2007

EN61000-3-2:2006

EN61000-3-3:2008 Class A

EN 55024:1998/A1:2001/A2:2003

IEC 61000-4-2:2009

IEC 61000-4-3:2006/A1:2008

IEC 61000-4-4:2004

IEC 61000-4-5:2005

IEC 61000-4-6:2009

IEC 61000-4-8:2001

IEC 61000-4-11:2004

Table of Contents

1. Introduction.....	5
1.1 Features.....	6
1.2 Specifications.....	7
1.3 Model Specifications.....	11
1.4 Special Functions.....	11
2. Installation.....	13
2.1 Unpacking.....	13
2.2 Safety Cautions.....	13
2.3 DIN-Rail Mounting.....	14
2.4 Mounting on a Plane Surface.....	18
2.5 Applying Power.....	21
2.6 Making Copper Port Connection.....	22
2.7 Making Fiber Port Connection.....	23
3. LED Indicators.....	24
3.1 States and Indications.....	24
Appendix. On-board Configuration.....	25

1. Introduction

The industrial 10/100BASE-TX to 100BASE-FX media converter series provides industrial strength Ethernet copper-to-fiber media conversion, allowing for 10Base-T-100Base-FX or 100Base-TX-100Base-FX over multi-mode or optional single-mode fiber optical media.

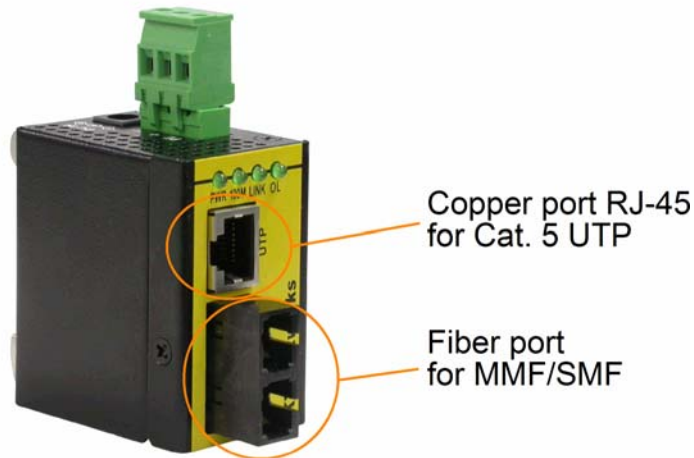

In addition to the basic media conversion functions, the converters also provide some special functions to enhance the flexibility for wide application needs as follows:

AUTO-NEGO FUNCTION

The copper port is featured this function which performs a negotiation process for the speed and duplex configuration with the connected device automatically when each time a link is being established.

AUTO-CROSS FUNCTION

The copper port is featured this function that allows to auto-detect the twisted-pair signals and adapts itself to form a valid MDI to MDI-X connection with the remote connected device automatically.

FAR END FAULT FUNCTION

The fiber port is facilitated with this function, which conforms to IEEE 802.3u 100BASE-FX specifications. When the port detects a link failure on its receiving circuitry, it will send out an FEFI (Far End Fault Indication) signal to the remote connected device to indicate a remote fault is detected. It also is capable to receive FEFI signal sent from the remote link partner. Upon receiving an FEFI signal, it indicates a link failure occurred on the transmitting path. This function allows the converter to report a fiber link fault even when a link failure occurred on transmitting fiber cable.

SMART-FORWARDING FUNCTION

The converter uses store-and-forward mechanism for packet forwarding normally when both media ends

operate at different speed, but switches to direct conversion automatically and with the least latency when both media ends operate at the same speed.

LINK FAULT PASS THROUGH FUNCTION

The function allows the link fault status passes through from one media end to another media end transparently.

INDUSTRIAL ENHANCEMENT

For industrial environment, the converters are designed with the following enhanced features exceeding that of commercial media converters:

- High and wide operating Temperature
- Wide operating voltage range for DC power input
- Power input interfaces: Terminal block for industrial power supply and DC jack for typical power adapter
- DIN-Rail mounting support for industrial enclosure
- Screw plane mounting support for industrial enclosure
- Industrial-rated Emission and Immunity performance

1.1 Features

- Convert speed and media type
- Support full wire speed conversion
- Support 10Mbps and 100Mbps speed on the copper connections
- Auto MDI/MDI-X detection function on the copper port
- Auto-negotiation function on the copper port
- Link fault pass through function
- Plug and play with no complicated configuration
- Transparent conversion to 802.1Q VLAN tagged packets
- Far End Fault function on the fiber port
- Support wide range of fiber options on the fiber port
- Low power consumption
- Two power interface types: screw terminal block and DC jack
- Wide operating voltage input range
- Support DIN rail mounting
- Support plane mounting
- High and wide operating temperature range
- Industrial-rated Emission and Immunity performance

1.2 Specifications

This figure shows the important components of the converters:

Model KFC-241-L

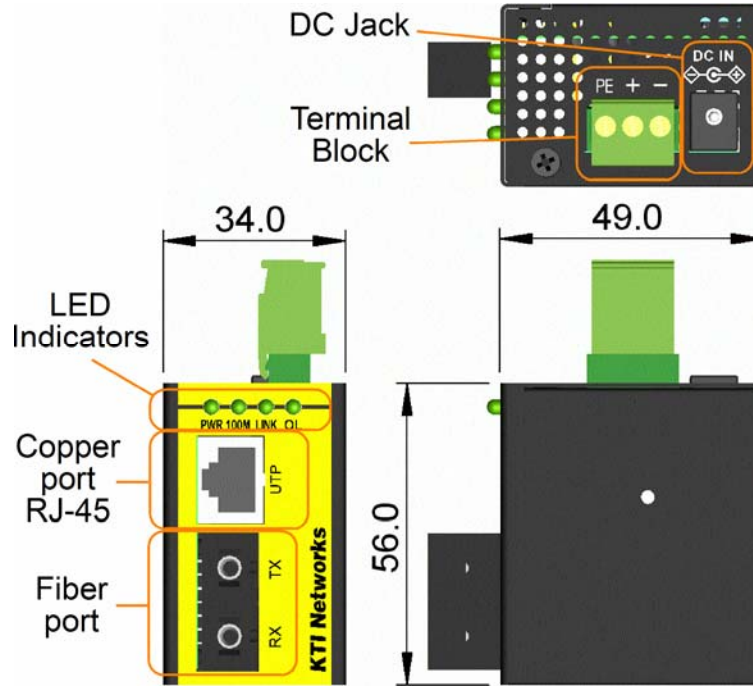

Model KFC-241-H

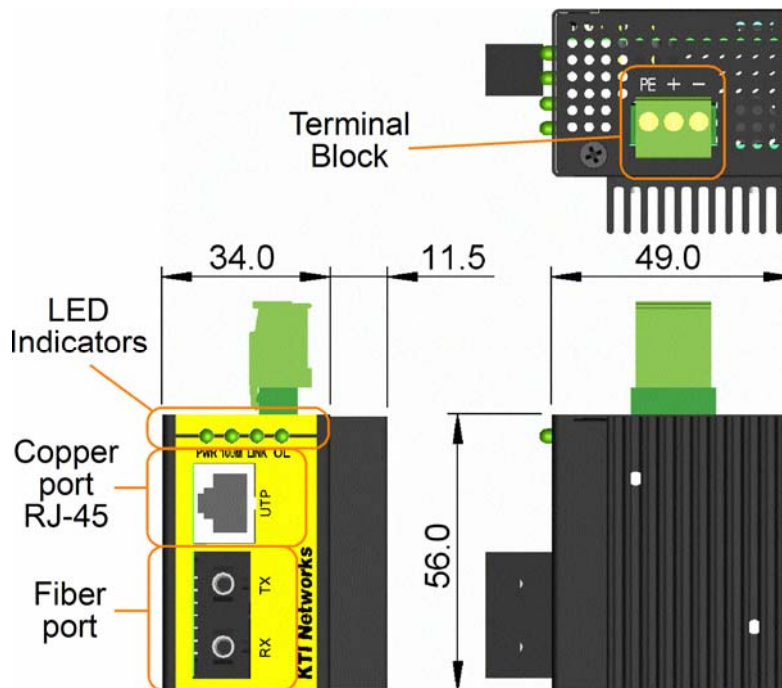

Copper Port (Twisted-Pair Interface)

Connector	Shielded RJ-45
Pin Assignments	Auto MDI/MDI-X detection
Signal Compliance	IEEE 802.3 10BASE-T, 802.3u 100BASE-TX
Data Speed	10Mbps or 100Mbps
Duplex Mode	Half-duplex or Full-duplex
Configuration	Auto-negotiation capable for speed and duplex
Cable Types	10Mbps - Category 3, 4, or 5 UTP 100Mbps - Category 5 UTP
Supported Link Distance	Up to 100 meters

FX Port (Fiber Optic Interface)

Signal Compliance	IEEE 802.3u 100BASE-FX
Connector	SC, ST, or Single SC (model dependent)
Data Speed	100Mbps
Duplex Mode	Full-duplex and optional half duplex
Cable Types	Multimode (MMF) - 50/125, 62.5/125 μ m Single mode (SMF) - 9/125 μ m
Supported Link Distance	MMF up to 2km SMF, single SMF (model dependent)
Eye Safety compliance	IEC825 Class 1

DC Power Input

KFC-241-L

Interfaces	Screw-type Terminal Block 3P (TB-3P) DC Jack (-D 6.3mm /+D 2.0mm)
Operating Input Voltages	+4.5VDC ~ +50VDC
Power	Consumption 1.6W @+7.5VDC input 1.6W @+12VDC input 2W @+48VDC input

KFC-241-H

Interface	Screw-type Terminal Block 3P (TB-3P)
Operating Input Voltage	+110VDC
Power	Consumption 2.9W @+110VDC input

LED Indicators

LED Name	Display function
PWR	Power status
LINK	Link status
100M	Copper port operating speed
OL	Fiber port optical link

Mechanical

Dimension (base)	KFC-241-L - W 34mm x D 49mm x H 56mm KFC-241-H - W 45.5mm x D 49mm x H 56mm
Weight	KFC-241-L - 132g KFC-241-H - 164g
Housing	Enclosed metal with no fan
Mounting Support	DIN-rail mounting, Plane mounting

Environmental

Operating Temperature	Ambient -20°C ~ 70°C
Storage Temperature	-30°C ~ 85°C
Relative Humidity	5% ~ 90%

Basic Information

Forwarding Throughput	Full wire speed at 100M full duplex 10Mbps - 14,880pps at 64-byte packets 100Mbps - 148,800pps at 64-byte packets
Packet Types	Transparent and no modification for - IEEE 802.3 standard packets - IEEE 802.1Q VLAN tagged packets
Packet Length	Up to 1600 bytes under 100Mbps-10Mbps conversion No limit under 100Mbps to 100Mbps conversion
Flow Control	Back-pressure for half-duplex mode 802.3x pause-frame base for full duplex mode

Certificate

FCC	Part 15 Class A
CE/EMC	EMI EN50081-1 Class A EMS EN55024
CE/LVD Safety	EN 60950

EN 50081-1:

EN55022 CISPR Class B
EN61000-3-2 Device <75W
EN61000-3-3 Clause 5

EN 55024

Severity Level

IEC 61000-4-2	ESD Test	Contact +/-6KV/Air +/-8KV
IEC 61000-4-3	RS Test	Power/Data Ports Level 3
IEC 61000-4-4	EFT/BURST Test	DC IN +/-2KV/Data Ports +/-4KV
IEC 61000-4-5	Surge Test	DC IN +/-0.5KV/Data Ports +/-1KV
IEC 61000-4-6	CS Test	DC IN / Data Ports Level 3
IEC 61000-4-8	Magnetic Field	50Hz 40A/m
IEC 61000-4-11	Voltage Int. Dips	Interruption >95% 250periods Dips 30% 25periods Dips >95% 0.5period

1.3 Model Specifications

The media converter series provides the following fiber options:

Model Ext.	Connector	Wavelength	Fiber Distance	Tx power	Sensitivity	Rx Power max.
-T	Duplex ST	1310nm	MMF 2km	-20 ~ -14	-31 max.	0 min.
-C	Duplex SC	1310nm	MMF 2km	-20 ~ -14	-31 max.	0 min.
-SL2	Duplex SC	1310nm	SMF 20km	-18 ~ -7	-32 max.	0 min.
-SL3	Duplex SC	1310nm	SMF 30km	-15 ~ -8	-34 max.	0 min.
-SL6	Duplex SC	1310nm	SMF 60km	-5 ~ -0	-35 max.	0 min.
-W3515	BiDi SC	Tx 1310nm Rx 1550nm	SMF 15-20km	-14 ~ -8	-31 max.	0 min.
-W5315	BiDi SC	Tx 1550nm Rx 1310nm	SMF 15-20km	-14 ~ -8	-31 max.	0 min.

1.4 Special Functions

Auto MDI/MDI-X Function

This function allows the TP port to auto-detect the twisted-pair signals and adapts itself to form a valid MDI to MDI-X connection with the remote connected device automatically.

Auto-negotiation Function

The copper port is featured with auto-negotiation function and full capability in speed and duplex. It performs a negotiation process for the speed and duplex configuration with the connected device automatically when each time a link is being established.

Far End Fault Function

The FX port is facilitated with this function that conforms to IEEE 802.3u 100BASE-FX specifications. When the FX port detects a link failure on its receiving circuitry, it will send out an FEFI (Far End Fault Indication) signal to the remote connected device to indicate a remote fault is detected. It also is capable to receive FEFI signal sent from the remote link partner. Upon receiving an FEFI signal, it notes a link failure occurred on the transmitting path. This function allows the converter to report a fiber link fault even when a link failure occurred on transmitting fiber cable.

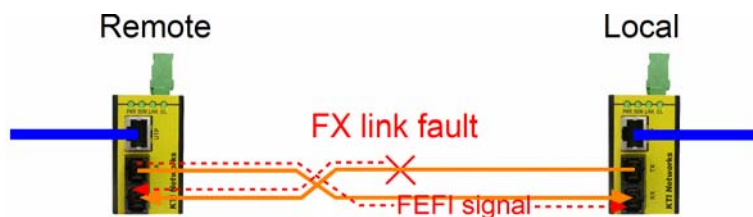

Link Fault Pass Through Function

When this function is enabled, a link fault detected on the TP copper port will force a link down on the FX fiber port and vice versa. Similarly, a link fault detected on the FX fiber port will also force a link down on the TP copper port.

The following figure illustrates a link fault on the fiber segment between the local and remote media converter devices is detected and both devices will force a link down on both copper segments.

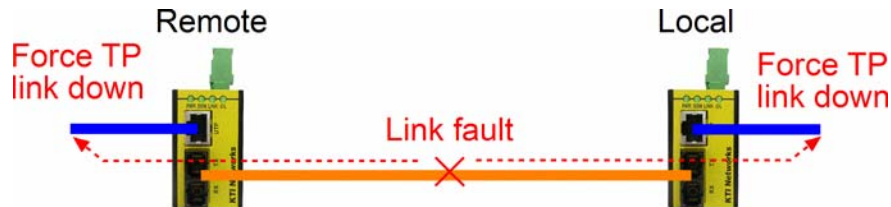

The following figure illustrates another example. A link fault happened on the copper cable is detected by the remote end. The fault is forwarded to the fiber segment and also forwarded to the copper cable at the local end by remote device and local device respectively.

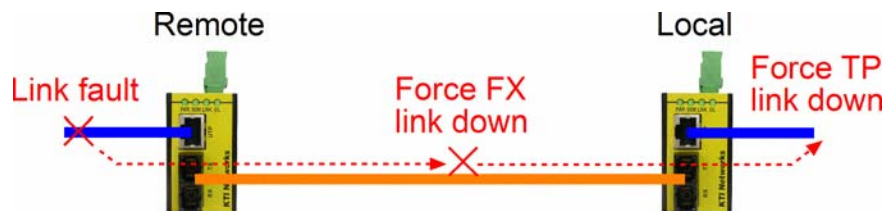

Smart-Forward Function

With this function, the media converter can change to direct conversion automatically when it detects same speed on both copper port and fiber port. Direct conversion method converts the signal between the copper port and the fiber port without storing the received packet on one port then forwarding to another port. The media converter operates with the minimum latency and has no size limit to the forwarded packets. In the case of 100Mbps to 10Mbps conversion, the media converter adapts itself to store-and-forward method for such unbalancing conversion automatically.

Note:

- 1. In direct conversion, be sure both devices connected to the TP port and FX port have same duplex mode for proper transmission.*
- 2. In direct conversion, 802.3x function is disabled and the media converter will not generate pause frame, but just forwards the received pause frame directly from one port to another port.*

2. Installation

2.1 Unpacking

Check that the following components have been included:

- Information CD
- The Media Converter unit
- DIN-rail mounting bracket (It may have been pre-installed on the device unit.)

The following are available optional accessories:

- Plane Mounting Bracket: The bracket is used for mounting the converter on a plane surface.
- Commercial-rated AC power adapters:
The adapters are used for supplying DC power to the converter via DC power jack interface.
- Industrial-rated power supply: The power can be used for supplying DC power to the converter via terminal block interface.

Contact sales representative for the availability.

Note: The operation temperature rating of the optional power adapters and power supply may differ from the rating of the media converters.

2.2 Safety Cautions

To reduce the risk of bodily injury, electrical shock, fire and damage to the product, observe the following precautions.

- Do not service any product except as explained in your system documentation.
- Opening or removing covers may expose you to electrical shock.
- Only a trained service technician should service components inside these compartments.
- If any of the following conditions occur, unplug the product from the electrical outlet and replace the part or contact your trained service provider:
 - The power cable, extension cable, or plug is damaged.
 - An object has fallen into the product.
 - The product has been exposed to water.
 - The product has been dropped or damaged.
 - The product does not operate correctly when you follow the operating instructions.
- Do not push any objects into the openings of your system. Doing so can cause fire or electric shock by shorting out interior components.

- Operate the product only from the type of external power source indicated on the electrical ratings label. If you are not sure of the type of power source required, consult your service provider or local power company.

2.3 DIN-Rail Mounting

In the product package, a DIN-rail bracket is provided and may have been pre-installed on the device unit for mounting the converter in an industrial DIN-rail enclosure.

The steps to mount the converter onto a DIN-rail are:

1. Install the mounting bracket onto the device unit as shown below:

Model: KFC-241-L

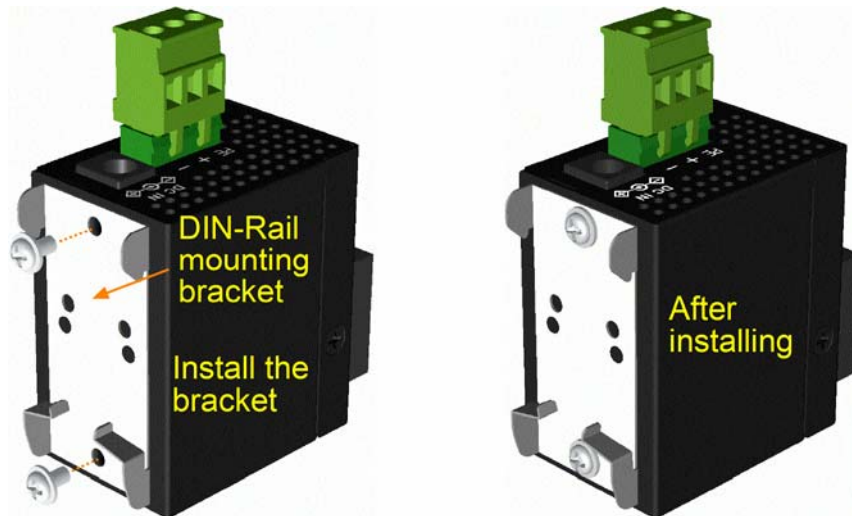

Model: KFC-241-H

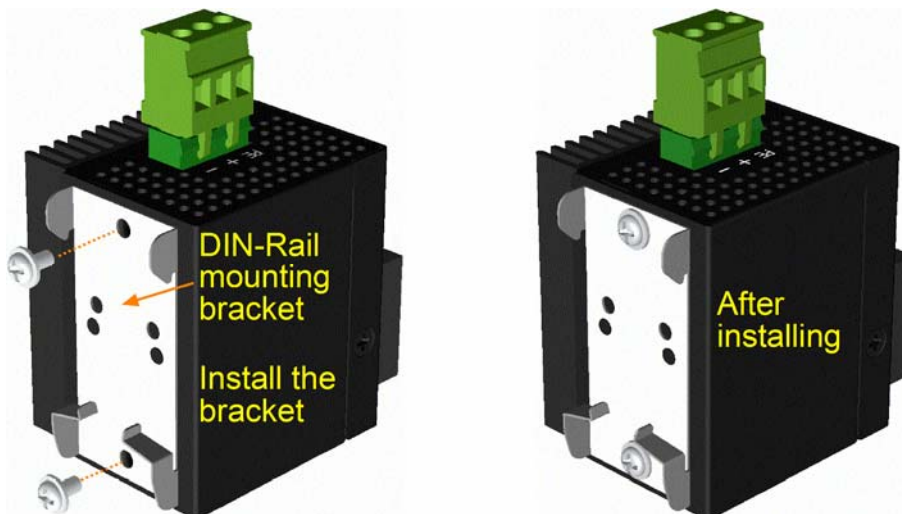

2. Attach bracket to the lower edge of the DIN rail and push the unit upward a little bit until the bracket can clamp on the upper edge of the DIN rail.

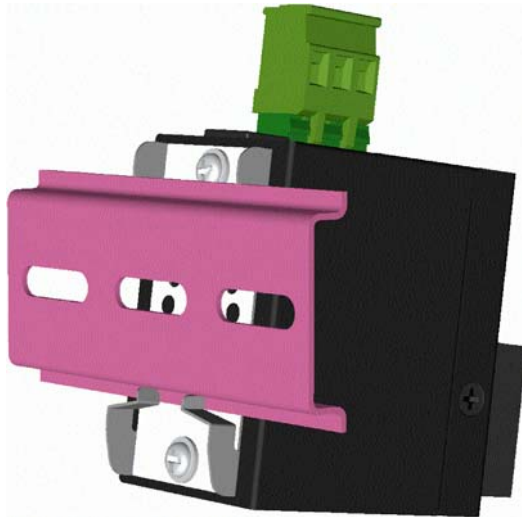

3. Clamp the unit to the DIN rail and make sure it is mounted securely.

Model: KFC-241-L

Model: KFC-241-H

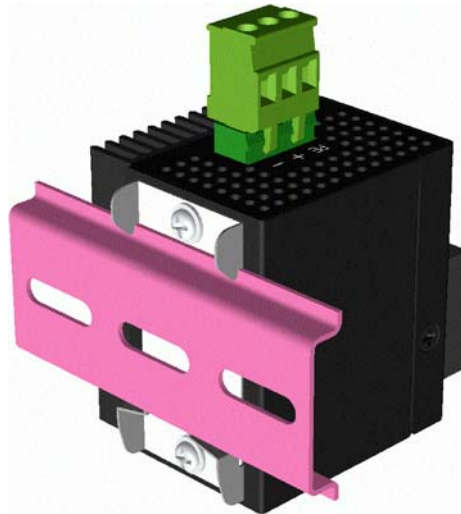

4. Make sure that there is proper heat dissipation from and adequate ventilation around the device.

The final mechanical dimensions after installing DIN-Rail mounting bracket are:

Model: KFC-241-L with DIN-Rail mounting bracket

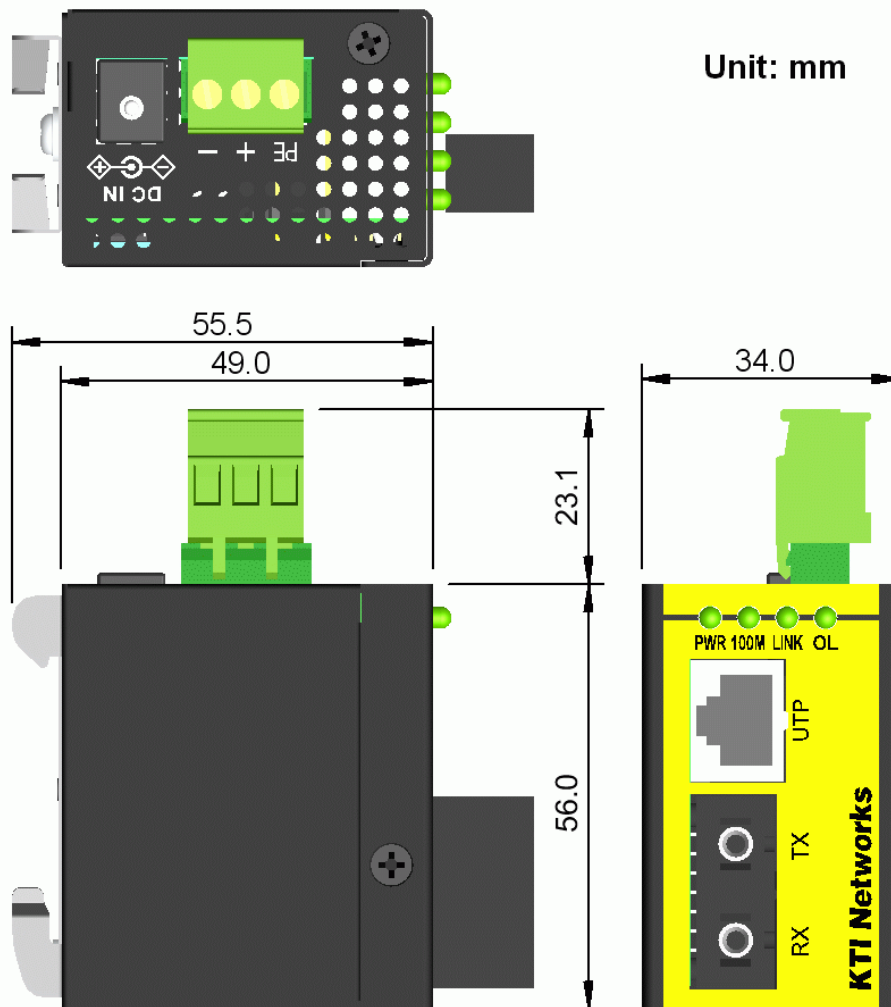

Model: KFC-241-H with DIN-Rail mounting bracket

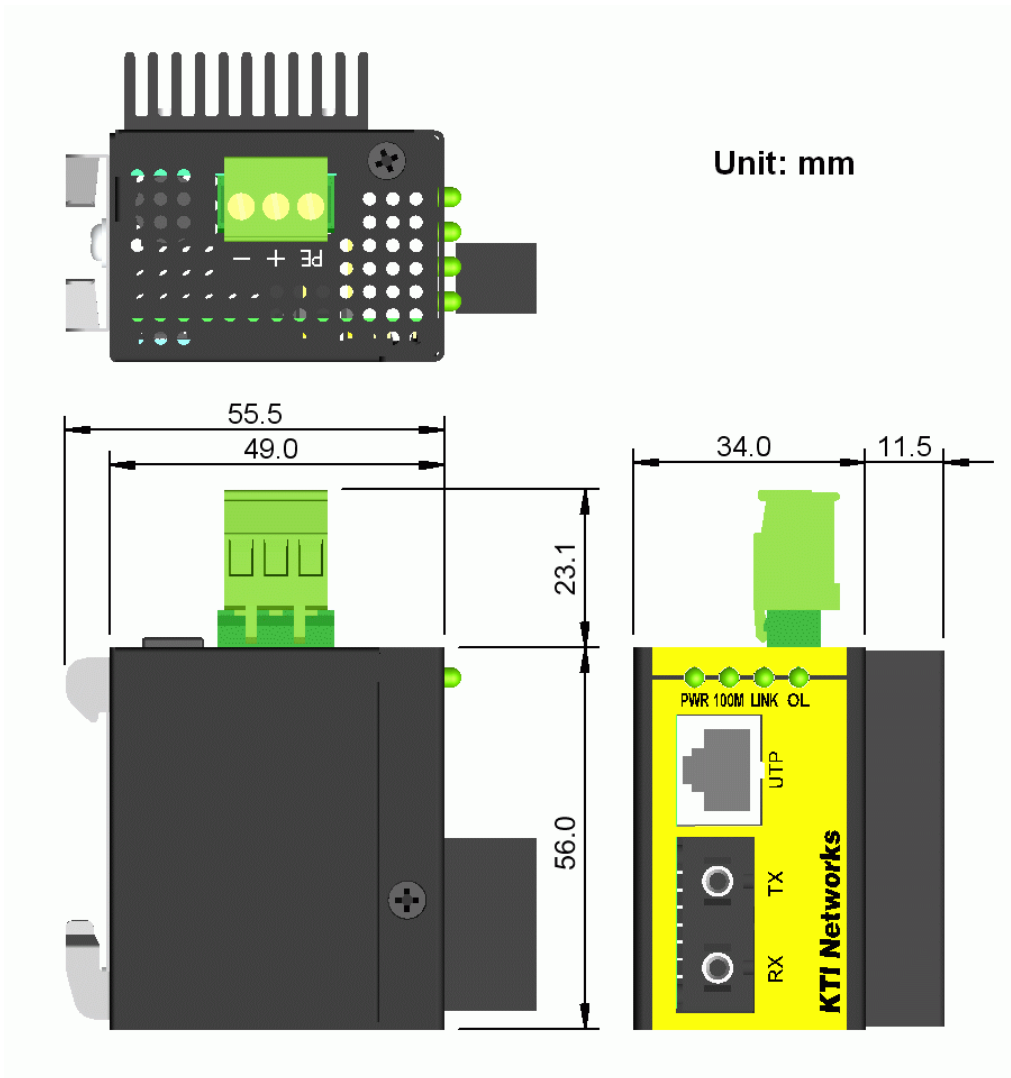

2.4 Mounting on a Plane Surface

An optional panel mounting bracket, as shown below is also available for mounting the converter on a plane surface such as a wall, a wood board, or a metal plate in an industrial enclosure.

Screw the bracket and install it on the converters.

Model: KFC-241-H

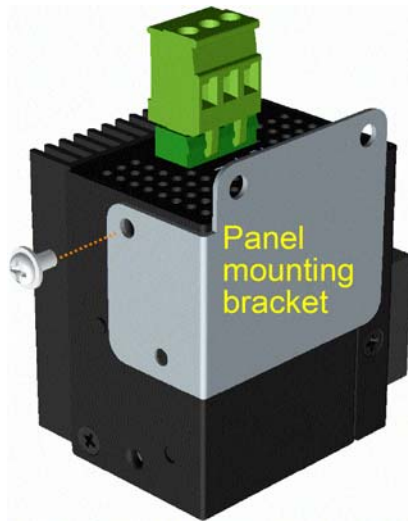

Model: KFC-241-L

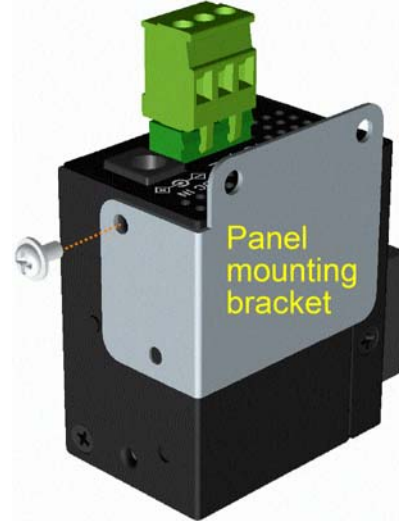

Make sure that there are proper heat dissipation from and adequate ventilation around the device. Do not place heavy objects on the device.

The final mechanical dimensions after installing panel mounting bracket are:

Model: KFC-241-L with panel mounting bracket

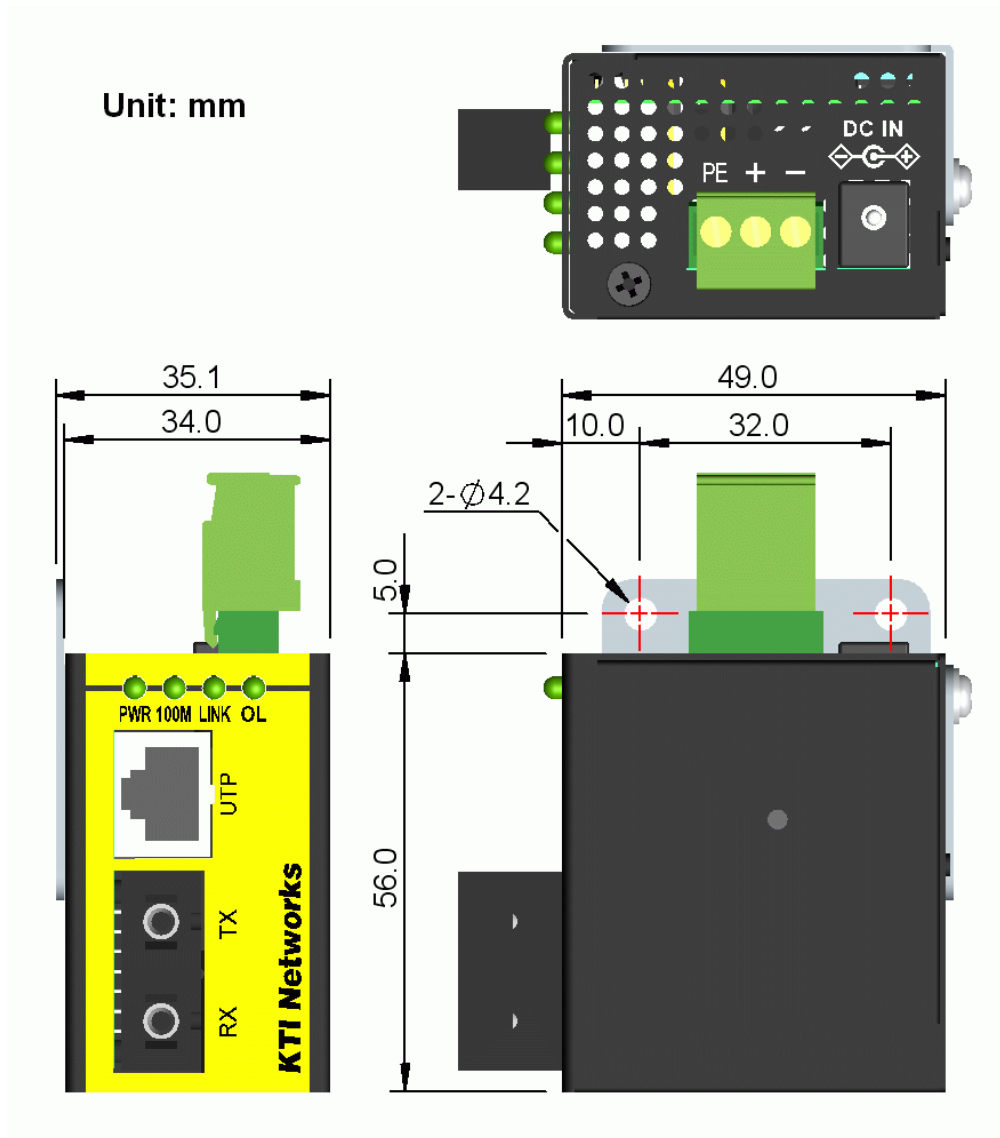

Model: KFC-241-H with panel mounting bracket

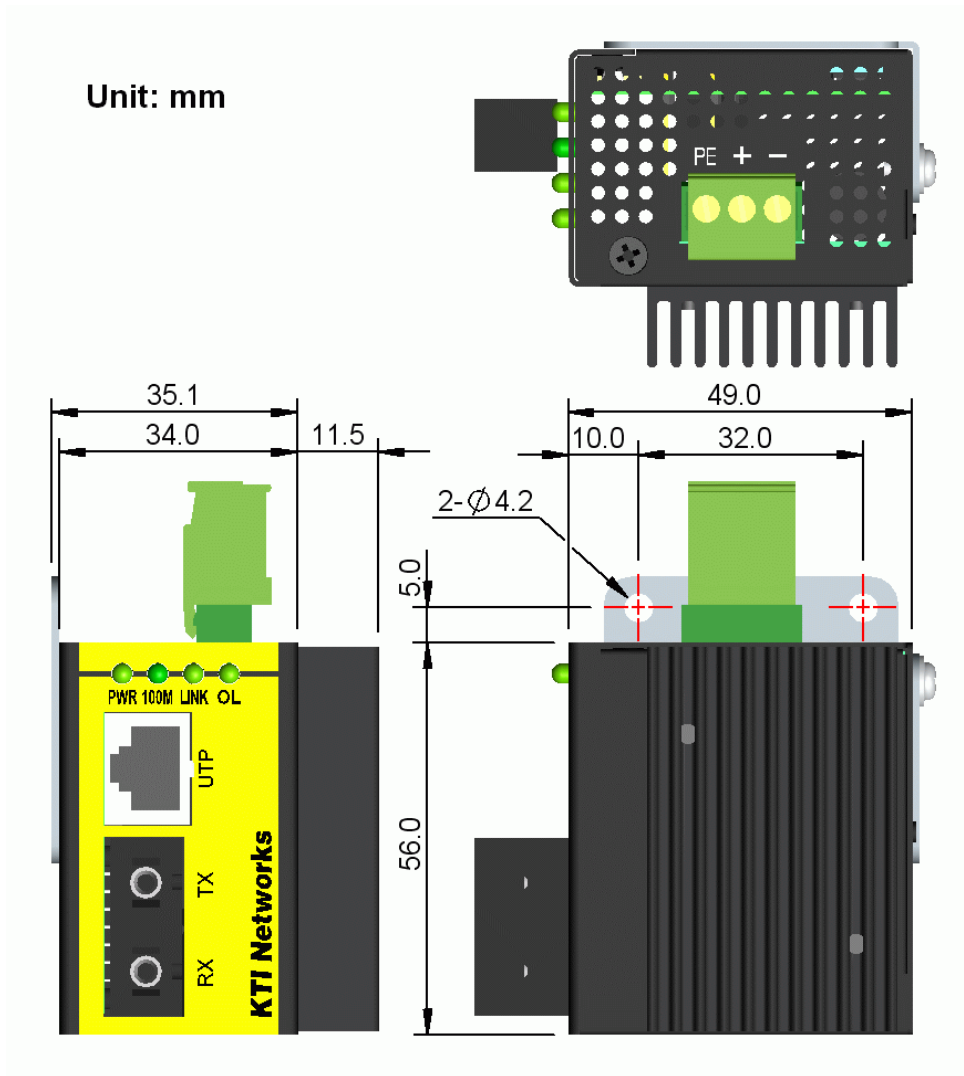

2.5 Applying Power

The converters provide two types of power interfaces, terminal block and DC power jack for receiving DC power input from external power supply.

KFC-241-L

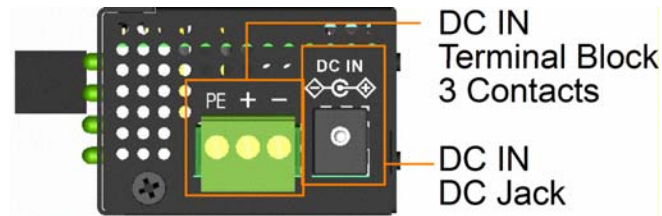

KFC-241-H

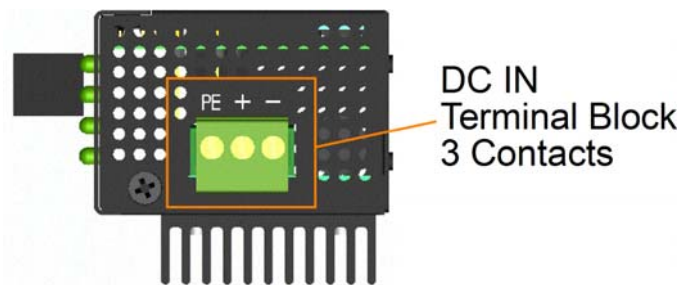

DC IN Terminal Block (TB-3P)

Connector	Screw-type Terminal Block 3P
Contacts	+ DC IN Positive (+) terminal
	- DC IN Negative (-) terminal
	PE Protective Earth (Case) terminal



Power wires 24 ~ 12AWG (IEC 0.5~2.5mm²)

DC Jack

Connector: Jack -D 6.3mm  +D 2.0mm
Interface to typical AC-DC power adapter plug

DC IN Specification

Model	KFC-241-L	KFC-241-H
Connectors	TB-3P, DC Jack	TB-3P
Voltage Range	+4.5 ~ +50VDC	+110VDC
Power Consumption	1.6W@+7.5V 1.6W@+12V 2W@+48V	2.9W@110V

2.6 Making Copper Port Connection

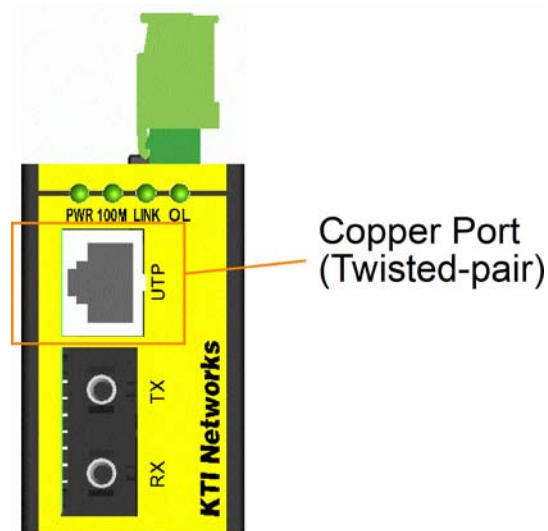

The copper port is featured to support connection to :

- Auto-negotiation devices
- Auto-negotiation incapable 100BASE-TX devices

Network Cables

10BASE-T: 2-pair UTP Cat. 3,4,5 , EIA/TIA-568B 100-ohm STP

100BASE-TX: 2-pair UTP Cat. 5, EIA/TIA-568B 100-ohm STP

Link distance: Up to 100 meters

Note: The TP port is featured with auto MDI/MDI-X crossover detection and configuration function. No matter a straight through cable or crossover cable is connected, the copper port can sense the receiving pair automatically and configure itself to match the rule for MDI to MDI-X connection.

2.7 Making Fiber Port Connection

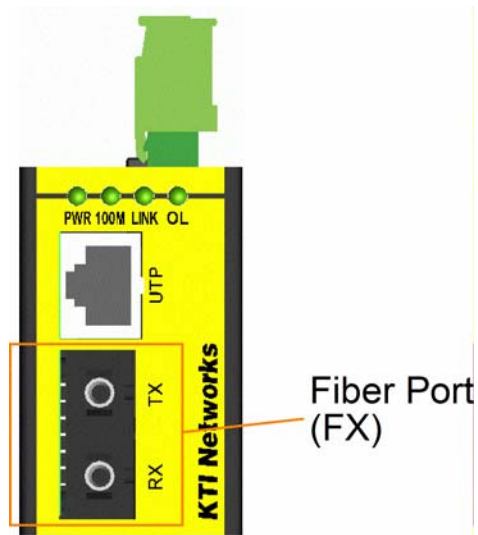

The fiber port operates on 100Mbps and full duplex. A variety of fiber options is provided as follows:

Model Optical Specifications

Model Ext.	Connector	Wavelength	Fiber Distance	Tx power	Sensitivity	Rx Power max.
-T	Duplex ST	1310nm	MMF 2km	-20 ~ -14	-32 max.	0 min.
-C	Duplex SC	1310nm	MMF 2km	-20 ~ -14	-31 max.	0 min.
-SL2	Duplex SC	1310nm	SMF 20km	-18 ~ -7	-32 max.	0 min.
-SL3	Duplex SC	1310nm	SMF 30km	-15 ~ -8	-34 max.	0 min.
-SL6	Duplex SC	1310nm	SMF 60km	-5 ~ -0	-35 max.	0 min.
-W3515	BiDi SC	Tx 1310nm Rx 1550nm	SMF 15-20km	-14 ~ -8	-31 max.	0 min.
-W5315	BiDi SC	Tx 1550nm Rx 1310nm	SMF 15-20km	-14 ~ -8	-31 max.	0 min.

Fiber Distance: A reference connection distance

Ext.: Extension of the model name

Con.: FX Connectors

Network Cables

MMF: Multimode fiber 62.5/125 μ m, 50/125 μ m

SMF: Single Mode fiber 9 /125 μ m

3. LED Indicators

The following figure shows the locations of LED indicators:

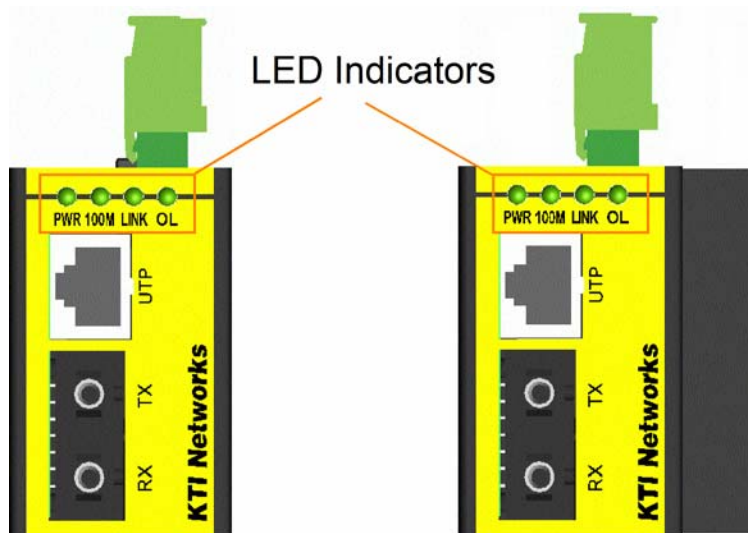

3.1 States and Indications

<u>LED</u>	<u>Display</u>	<u>State</u>	<u>Interpretation</u>
PWR	Power status	ON	Power on
		OFF	Power off
100M	TP port speed status	ON	Copper port operates in 100Mbps
		OFF	10Mbps
LINK	Port link status	ON	Link up and no traffic
		OFF	Link fault
		Blink	Rx/Tx activities
OL	FX port optical link	ON	Optical signal is detected
		OFF	No optical signal is detected

Appendix. On-board Configuration

Six configuration jumpers are provided on the internal PC board of the device. They can be used to change the configuration and adapt the device for some special applications. The jumpers are inaccessible by users.

Jumper Settings

JP1	TP auto mode	OFF	Auto-negotiation (factory default)
		ON	Forced mode
JP2	TP duplex	OFF	Full duplex (factory default)
		ON	Half duplex
JP3	TP speed	OFF	100Mbps (factory default)
		ON	10Mbps
JP4	Link Fault Pass Through	OFF	Enabled (factory default)
		ON	Disabled
JP5	Forward mode	OFF	Smart-mode (factory default)
		ON	Store-and-forward always
JP6	802.3x	OFF	Enable (factory default)
		ON	Disable

Note: Only the factory-authorized engineers are allowed to change the settings of the jumpers.