



# **Industrial Serial RS-232 to Fiber Converter**

KSC-200 Series

Installation Guide



DOC.070308-KSC-200

(C) 2006 KTI Networks Inc. All rights reserved. No part of this documentation may be reproduced in any form or by any means or used to make any directive work (such as translation or transformation) without permission from KTI Networks Inc.

KTI Networks Inc. reserves the right to revise this documentation and to make changes in content from time to time without obligation on the part of KTI Networks Inc. to provide notification of such revision or change.

For more information, contact:

**United States**

KTI Networks Inc.  
P.O. BOX 631008  
Houston, Texas 77263-1008

Phone: 713-2663891  
Fax: 713-2663893  
E-mail: [kti@ktinet.com](mailto:kti@ktinet.com)  
URL: <http://www.ktinet.com/>

**International**

Fax: 886-2-26983873  
E-mail: [kti@ktinet.com.tw](mailto:kti@ktinet.com.tw)  
URL: <http://www.ktinet.com.tw/>

The information contained in this document is subject to change without prior notice. Copyright (C) All Rights Reserved.

#### TRADEMARKS

Ethernet is a registered trademark of Xerox Corp.

#### FCC NOTICE

This device complies with Class B Part 15 the FCC Rules. Operation is subject to the following two conditions: (1) This device may not cause harmful interference, and (2) this device must accept any interference received including the interference that may cause.

#### CE NOTICE

Marking by the symbol  indicates compliance of this equipment to the EMC directive of the European Community. Such marking is indicative that this equipment meets or exceeds the following technical standards:

EMC Class B

EN 50081-1/1992 : EN55022:1994/A1:1995/A2:1997 Class B

EN61000-3-2:2000

EN61000-3-3:1995/A1:2001

EN 55024:1998/A1:2001

IEC 61000-4-2:1995

IEC 61000-4-3:1995

IEC 61000-4-4:1995

IEC 61000-4-5:1995

IEC 61000-4-6:1996

IEC 61000-4-8:1993

IEC 61000-4-11:1994

# Table of Contents

<b>1. Introduction .....</b>	<b>5</b>
1.1 Features .....	6
1.2 Specifications .....	7
<b>2. Installation .....</b>	<b>11</b>
2.1 Unpacking .....	11
2.2 Safety Cautions .....	12
2.3 DIN-Rail Mounting .....	13
2.4 Panel Mounting .....	15
2.5 Applying Power .....	17
2.6 Power Failure Relay Output .....	20
2.7 Making Serial RS-232 Connection .....	20
2.7.1 RS-232 Port Pin Assignment Table .....	21
2.7.2 Cable for Connection to PC COM Port .....	22
2.8 Making Fiber Port Connection .....	23
2.9 Application .....	25
<b>3 LED Indicators .....</b>	<b>26</b>
3.1 LED Indicators .....	26
<b>Appendix: Model Optical Specifications .....</b>	<b>27</b>

# 1. Introduction

---

The converter is designed to provide the most versatile connection possible between two RS-232 serial equipment using fiber optic cable. It allows any two pieces of serial equipment to communicate full-duplex over typical duplex fibers, or over optional single fiber up to 20km. The converter supports transparent conversion for not only RS-232 data lines, but also all RS-232 control signals. It also supports all RS-232 baud rates with no need for user configuration. The Din-rail mountable design makes it ideal for industrial cabinets and enclosures.



For industrial environment, the converters are designed with the following enhanced features exceeding that of commercial media converters:

- High and wide operating Temperature
- Wide operating voltage range for DC power input
- Power input interface: Industrial screw terminal block and DC power jack for external commercial power adapter as option
- DIN rail mounting support for industrial enclosure
- Screw panel mounting support for industrial enclosure
- Industrial-rated Emission and Immunity performance

## 1.1 Features

- Transparent conversion for all RS-232 signals
- Supports RS-232 baud rate higher than 115.2K bps
- Auto adaptation and conversion to any RS-232 baud received
- Operation with no required configuration
- Extending all RS-232 signals over long optical cables
- Supports versatile optical cables:
  - ST/SC multimode duplex fibers
  - SC single mode duplex fibers
  - SC single mode single fiber
- Provides surge protection (transient voltage) on RS-232 signals
- Provides high ESD protection on RS-232 signals
- Provides optical isolation between RS-232 and main circuitry
- Low power consumption
- Two power interface type: screw terminal block and DC jack
- Wide operating voltage input range
- Support DIN rail mounting
- Support panel mounting
- High and wide operating temperature range
- Industrial-rated Emission and Immunity performance

## 1.2 Specifications

This figure shows the important components of the device:

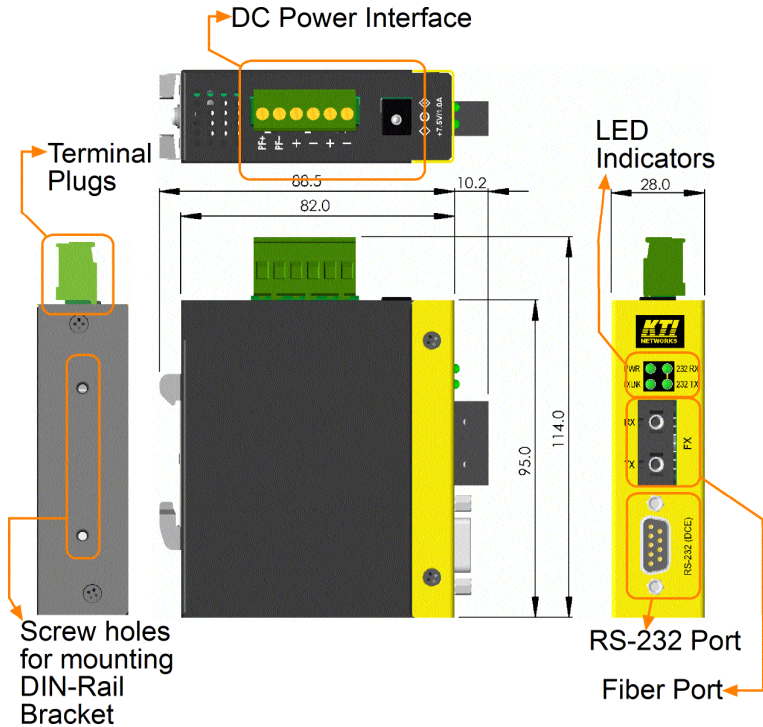

### **Serial Interface (RS-232 Port)**

Connector	DB9 female
Pin Assignments	DCE type
Isolation	RS-232 I/O and internal system
Baud Rate Support	Auto-detect, Up to 120K
Connector Shield	Connect to chassis ground
Connection Distance	15 meters
High ESD Tolerance	+/-15KV on Tx, Rx lines
Overvoltage Protection	Cutoff if over +/-25V
Isolation	Optical isolation from internal system

### **Fiber Optic Interface (Fiber Port)**

Connector	Duplex ST, Duplex SC, or Bi-Di SC
Data Speed	100Mbps
Duplex Mode	Full duplex
Cable Types	MMF - 50/125, 62.5/125 SMF - 9/125
Link Distance	MMF up to 2 km SMF -model dependent
Eye Safety compliance	IEC825 Class 1

Refer to Appendix for detailed optical specifications.

### **LED Indicators**

<b><u>LED</u></b>	<b><u>DISPLAY</u></b>	<b><u>STATE</u></b>	<b><u>INTERPRETATION</u></b>
PWR	Power status	ON	Power on
		OFF	Power off
TX	RS-232 Tx	BLINK	RS-232 Tx Activity status
RX	RS-232 Rx	BLINK	RS-232 Rx Activity status
FXLNK	Optical status	ON	Fiber port optical signal detected
		OFF	Fiber port no optical signal



## **DC Power Interface**

Interface

Screw-type terminal block

1. Two pairs for power wire cascading
2. One pair for power failure relay output

DC Jack (-6.3mm/+D2.0mm)

Operating Input Voltages

+7V ~ +30V(+5%)

Power consumption

2.1W @+7.5VDC input

2.14W @+12.6VDC input

2.4W @+30VDC input

## **Basic Information**

Conversion

Transparent for all RS-232 signals

## **Mechanical**

Dimension (base)

W 28mm x D 82mm x H 95mm

Housing

Enclosed metal with no fan

Mounting Support

DIN-rail mounting, Panel mounting

Weight

248g

## **Environmental**

Operating Temperature

Typical -20°C ~ 70°C (model dependent)

Storage Temperature

-20°C ~ 85°C

Relative Humidity

5% ~ 90%

## **Certificate**

FCC

Part 15 Class B

CE/EMC

EMI EN50081-1 Class B

EMS EN55024

CE/LVD Safety

EN 60950

### EN 50081-1/1992 :

EN55022:1994/A1:1995/A2:1997

EN61000-3-2:2000

EN61000-3-3:1995/A1:2001

### EN 55024:1998/A1:2001

IEC 61000-4-2:1995 ESD Test

IEC 61000-4-3:1995 RS Test

IEC 61000-4-4:1995 EFT/BURST Test

IEC 61000-4-5:1995 Surge Test

IEC 61000-4-6:1996 CS Test

IEC 61000-4-8:1993 Magnetic Field

IEC 61000-4-11:1994 Volatge Int. Dips

## 2. Installation

---

### 2.1 Unpacking

Check that the following components have been included:

- Information CD
- The device unit
- DIN-rail mounting bracket

If any item is found missing or damaged, please contact your local reseller for replacement.

The following are available optional accessories:

- Panel Mounting Bracket  
The bracket is used for mounting the device on a panel surface.
- Commercial-rated AC power adapters:
  - Rated AC120V/60Hz DC7.5V 1A
  - Rated AC230V/50Hz DC7.5V 1A
  - Rated AC100V/50-60Hz DC7.5V 1A
  - Rated AC240V/50Hz DC7.5V 1A

The adapters are used for supplying DC power to the converter via DC power jack interface.

## 2.2 Safety Cautions

To reduce the risk of bodily injury, electrical shock, fire, and damage to the equipment, observe the following precautions.

- Do not service any product except as explained in your system documentation.
- Opening or removing covers may expose you to electrical shock. Only a trained service technician should service components inside these compartments.
- If any of the following conditions occur, unplug the product from the electrical outlet and replace the part or contact your trained service provider:
  - The power cable, extension cable, or plug is damaged.
  - An object has fallen into the product.
  - The product has been exposed to water.
  - The product has been dropped or damaged.
  - The product does not operate correctly when you follow the operating instructions.
- Do not push any objects into the openings of your system. Doing so can cause fire or electric shock by shorting out interior components.
- Operate the product only from the type of external power source indicated on the electrical ratings label. If you are not sure of the type of power source required, consult your service provider or local power company.

## 2.3 DIN-Rail Mounting

In the product package, a DIN-rail bracket is installed on the device for mounting the converter in a industrial DIN-rail enclosure.

The steps to mount the device onto a DIN rail are:

1. Install the mounting bracket onto the device unit as shown below:

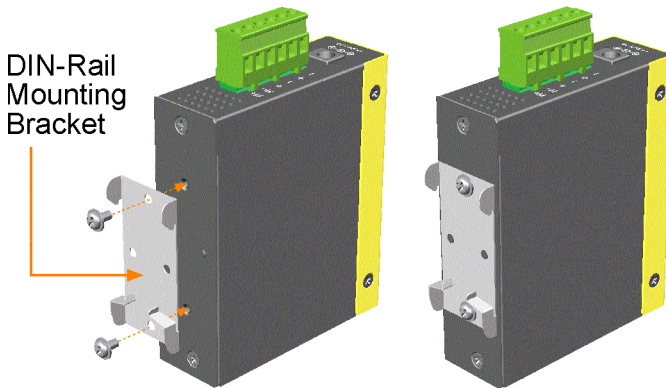

2. Attach bracket to the lower edge of the DIN rail and push the unit upward a little bit until the bracket can clamp on the upper edge of the DIN rail.
3. Clamp the unit to the DIN rail and make sure it is mounted securely.
4. Make sure that there are proper heat dissipation from and adequate ventilation around the device.

DIN-Rail

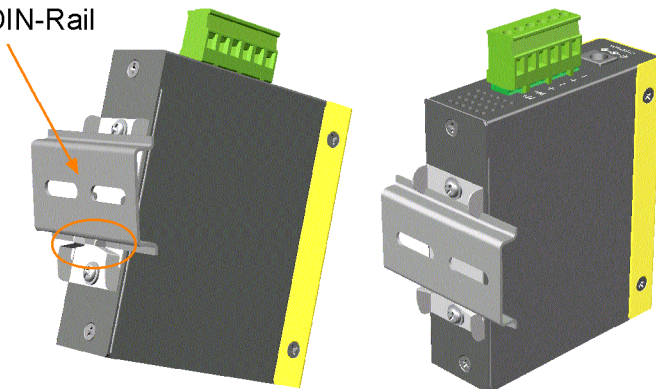

The final mechanical dimensions after installing DIN rail mounting bracket are:

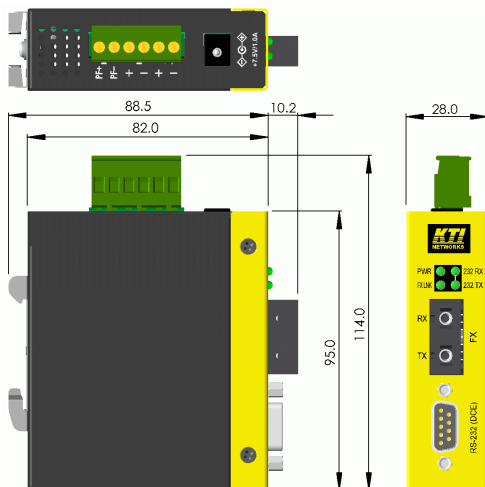

## 2.4 Panel Mounting

The device is provided with an optional panel mounting bracket. The bracket support mounting the device on a plane surface securely. The mounting steps are:

1. Install the mounting bracket on the device unit.
2. Screw the bracket on the device unit.

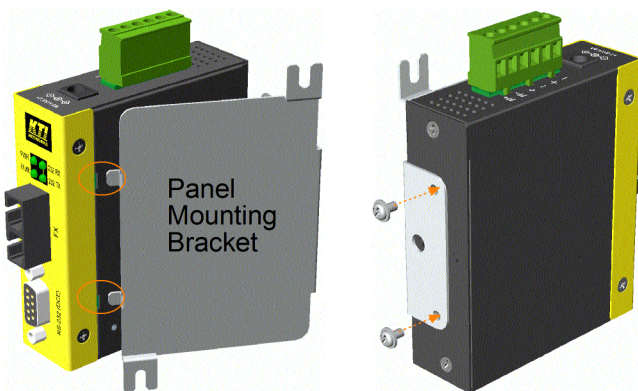

3. Screw the device unit on a panel.
4. Make sure that there are proper heat dissipation from and adequate ventilation around the device. Do not place heavy objects on the device.

The screw locations and final dimension are shown below:

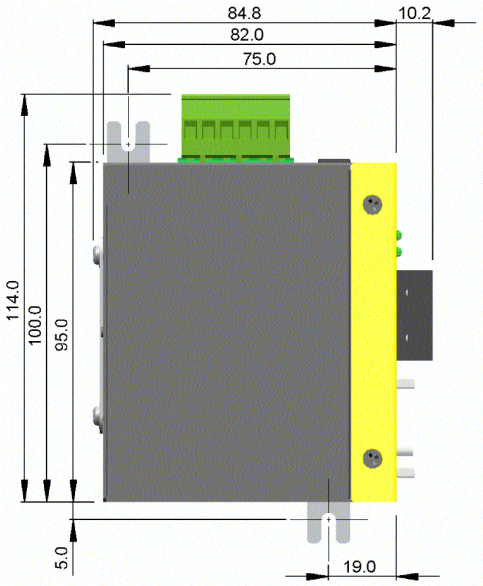



## 2.5 Applying Power

The power specifications of the device are:

Operating Voltage +7~+30VDC

Power Consumption Max.2.4W @30VDC

The device provides two types of power interfaces, terminal block and DC power jack for receiving DC power input from external power supply.

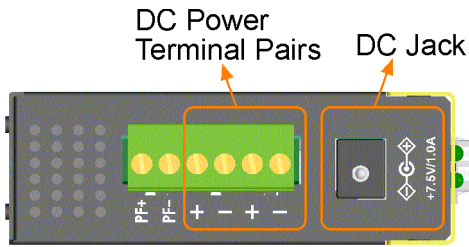

### Using Terminal Blocks

Either DC1 interface or DC2 interface can be used to receive DC power from an external power system. Or, DC2 also can be used to deliver the power received on DC1 to next device in cascading way.

DC1 +        Vdc Positive (+) terminal

DC1 -        Vdc Negative (-) terminal

DC2 +        Vdc Positive (+) terminal

DC2 -        Vdc Negative (-) terminal

Three 2P terminal plugs are provided together with the device. Two of the three plugs are used for DC1 and DC2 interfaces respectively. The plug is shown below:



Power wires: 24 ~ 12AWG (IEC 0.5~2.5mm<sup>2</sup>)

Install the power source wires with the plug properly. Screw the wire with plug securely. Then, plug in DC1 contacts.

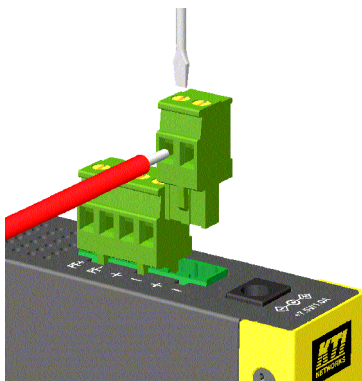

If cascading the power to next device is needed, install the power wires and plug for another switch. Then, use DC2 contacts.

*Note: Only up to four device units can be cascaded to receive power from one main power input source.*

## Using DC Power Jack

DC Jack Connector: Jack D 6.3mm —  + D 2.0mm

AC Power Adapters: Optional commercial rated adapters are available for purchasing.

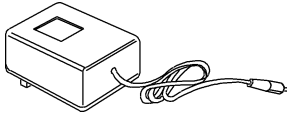

Rated AC120V/60Hz DC7.5V 1A

Rated AC230V/50Hz DC7.5V 1A

Rated AC100V/50-60Hz DC7.5V 1A

Rated AC240V/50Hz DC7.5V 1A

Connect power adapter DC plug to the DC power jack of the converter before connecting to the AC outlet. Connect the power adapter to the AC outlet.

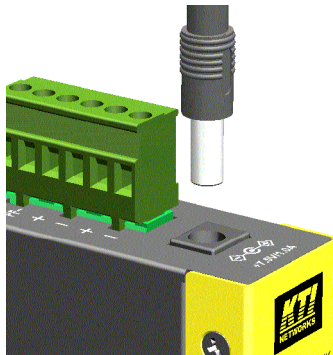

*Note: Before you begin the installation, check the AC voltage of your area. The AC power adapter which is used to supply the DC power for the unit should have the AC voltage matching the commercial power voltage in your area.*

## 2.6 Power Failure Relay Output

The device provides a relay output to report power failure event to a remote alarm monitoring system. The relay output is provided with two contacts labeled **PF+** and **PF-** in the terminal block interface.

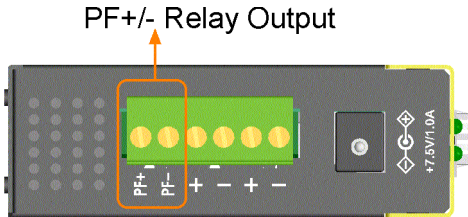

Use the provided 2P terminal plug for signal wiring and plug into the PF+/- contacts. The function is designed as :

Power is normal    PF+ contact is shorted with PF- contact.

Power failure      PF+ contact is disconnected with PF- contact.

*Note: Be sure the voltage applied on PF+/- contacts is within the specification of 30VDC/1A max. or 120VAC/0.5A max.*

## 2.7 Making Serial RS-232 Connection

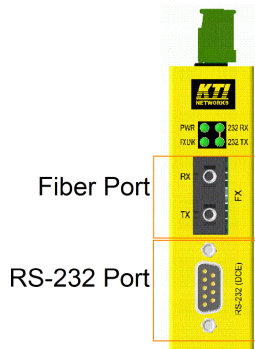

## 2.7.1 RS-232 Port Pin Assignment Table

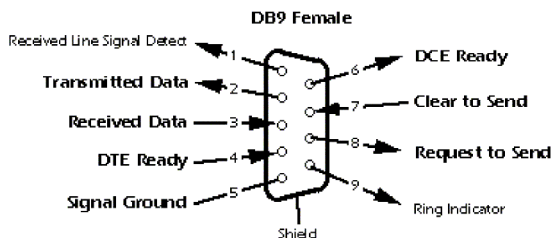

<u>Pin#</u>	<u>Signal Name</u>	<u>Input/Output</u>
1	Received Line Signal Detect	Output
2	TX Data	Output
3	RX Data	Input
4	DTE Ready	Input
5	Signal Ground	Output
6	DCE Ready	Output
7	Clear To Send	Input
8	Request To Send	Output
9	Ring Indicator	Output

## 2.7.2 Cable for Connection to PC COM Port

Connecting to 9-pin DTE device (Computer or PC COM)

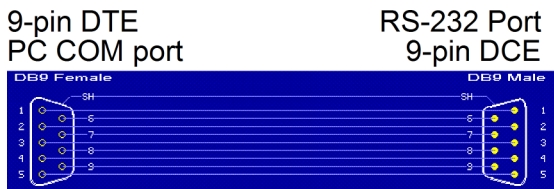

Connecting to 25-pin DTE device (Computer or PC COM)

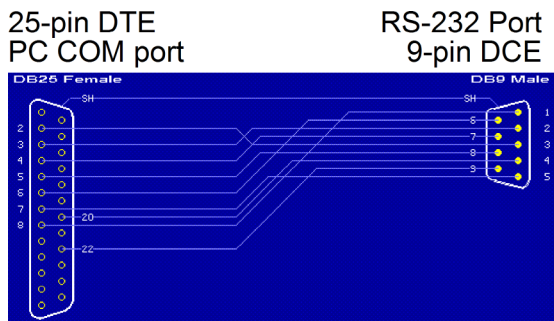

## 2.8 Making Fiber Port Connection

Depending on the model purchased, the fiber port provides one of the following connector types: Duplex ST, Duplex SC, Single SC.

### Connecting Multimode Duplex Fiber

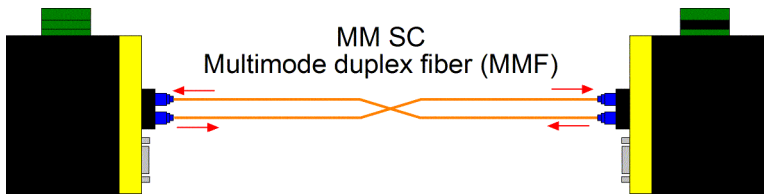
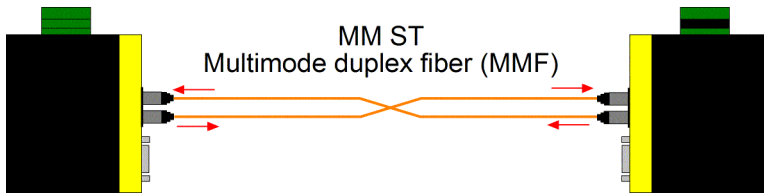

Make sure the RX-to-TX connection rule is followed on the both ends of the fiber cable.

### Connecting Single Mode Duplex Fiber

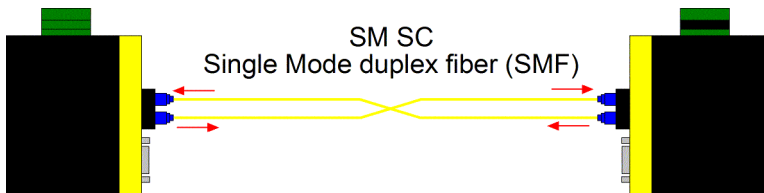

*Note: Make sure the RX-to-TX connection rule is followed on the both ends of the fiber cable.*

## Connecting Single Mode Single Fiber

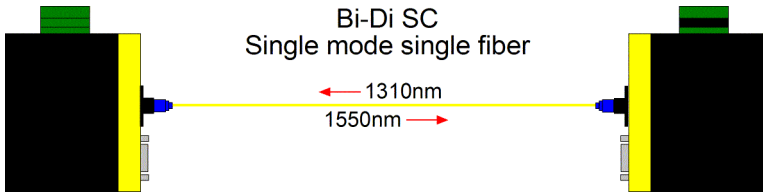

For Bi-Di (Bidirectional) single fiber connection which use two different wavelengths for TX and RX respectively over single SM fiber cable, only one connector is provided on the fiber port and only one fiber cable is used.

### Network Cables

Multimode (MMF) - 50/125, 62.5/125

Single mode (SMF) - 9/125

### Fiber Distance between two devices

<u>Model</u>	<u>Connector</u>	<u>Fiber</u>	<u>Distance (ref. max.)</u>
KSC-200-T	ST	MMF	2km
KSC-200-C	SC	MMF	2km
KSC-200-SL2	SC	SMF	20km
KSC-200-W3515	Bi-Di SC	Single SMF Tx 1310nm Rx 1550nm	15~20km
KSC-200-W5315	Bi-Di SC	Single SMF Tx 1550nm Rx 1310nm	15~20km

*Note: KSC-200-W3515 and KSC-200-W5315 must be connected together as a pair on both ends of the single fiber.*

For other longer distances, consult your dealer for more information.



## 2.9 Application

The converter can be used to extend the distance between two serial devices via fiber cables. The distance can be 2km, 20km, and even up to 100km.

The following example illustrates a PC performs serial communication with another RS-232 device far apart:

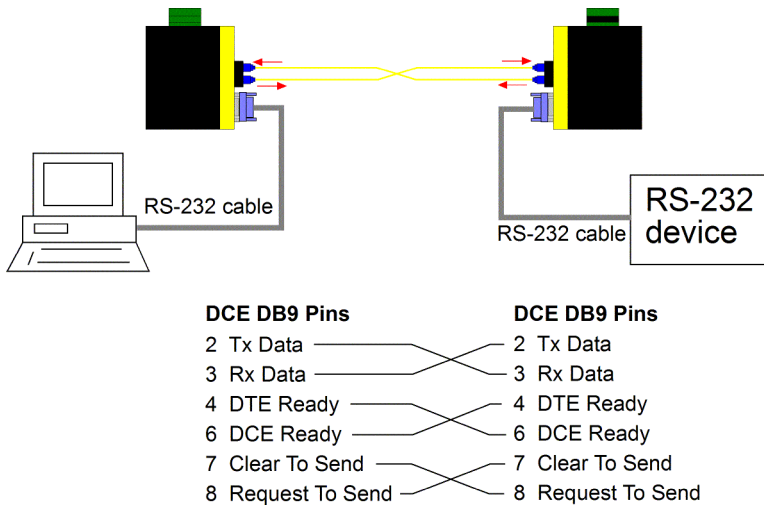

The converter converts all signals of the COM port of the PC to optical signals and sends to the other converter far apart over fiber cable.

### 3 LED Indicators

---

The following figure shows the locations of the LED indicators:

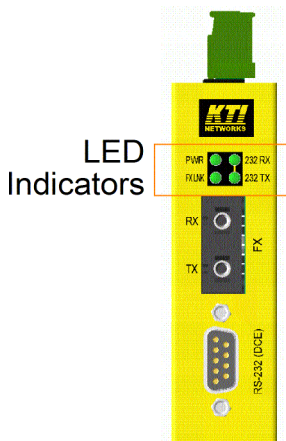

#### 3.1 LED Indicators

<u>LED</u>	<u>DISPLAY</u>	<u>STATE</u>	<u>INTERPRETATION</u>
PWR	Power status	ON	The device is powered on.
		OFF	The device is powered off.
232 TX	RS-232 TX	ON	RS-232 TX data is present
		OFF	No RS-232 TX data
232 RX	RS-232 RX	ON	RS-232 RX data is present
		OFF	No RS-232 RX data
FXLNK	Fiber port link	ON	Fiber port optical signal detected
		OFF	Fiber port no optical signal

## **Appendix: Model Optical Specifications**

---

### Model Fiber Port Specifications

<b><u>Model</u></b>	<b><u>FX</u></b>	<b><u>Wavelength</u></b>	<b><u>Tx Power</u></b>	<b><u>Sensitivity</u></b>	<b><u>Max.Rx</u></b>
200-T	ST	1310nm	-19~-14	-31dBm	-14dBm
200-C	SC	1310nm	-19~-14	-31dBm	-14dBm
200-SL2	SC	1310nm	-15~-7	-32dBm	-3dBm
200-W3515	BiDi SC	Tx 1310nm Rx 1550nm	-14~-8	-31dBm	0dBm
200-W5315	BiDi SC	Tx 1550nm Rx 1310nm	-14~-8	-31dBm	0dBm